

11a

Body



25

Finger

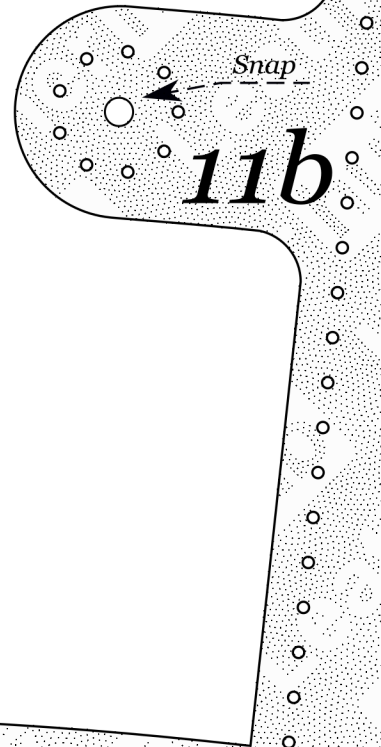
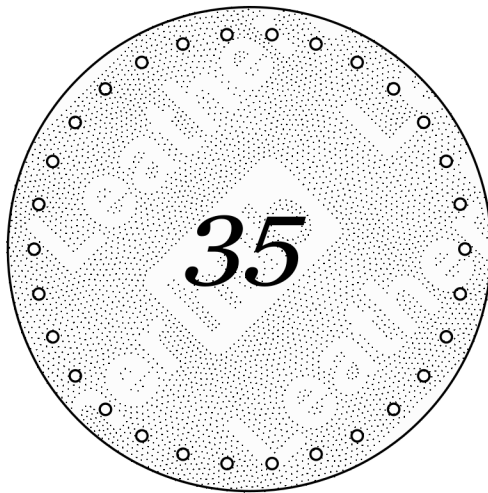
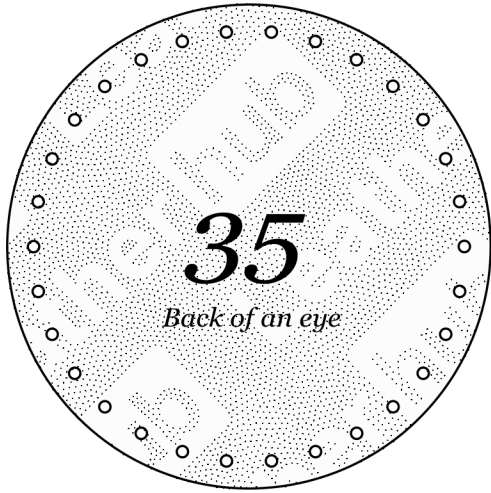

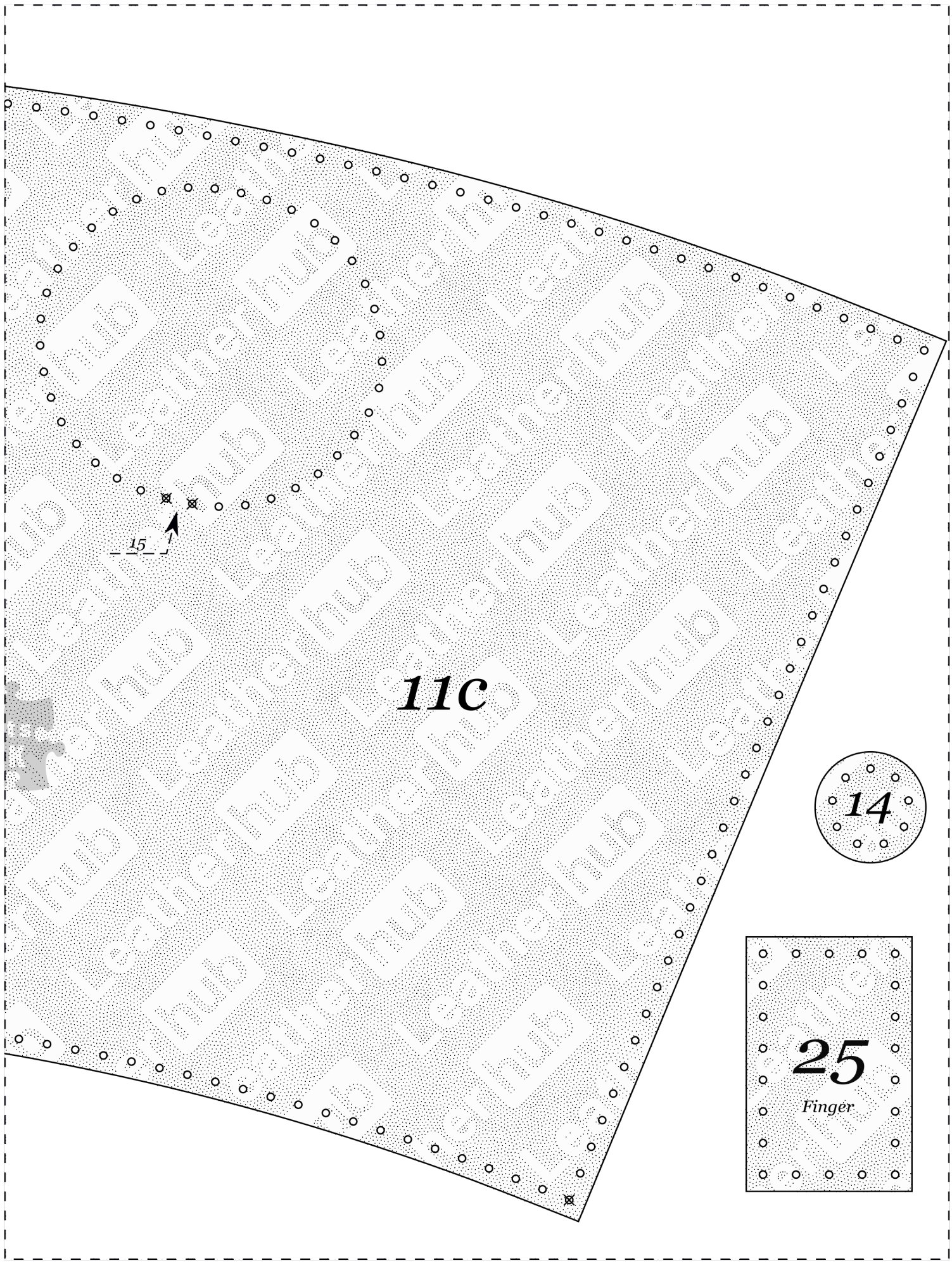

11C

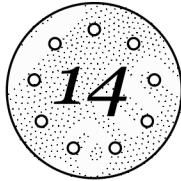

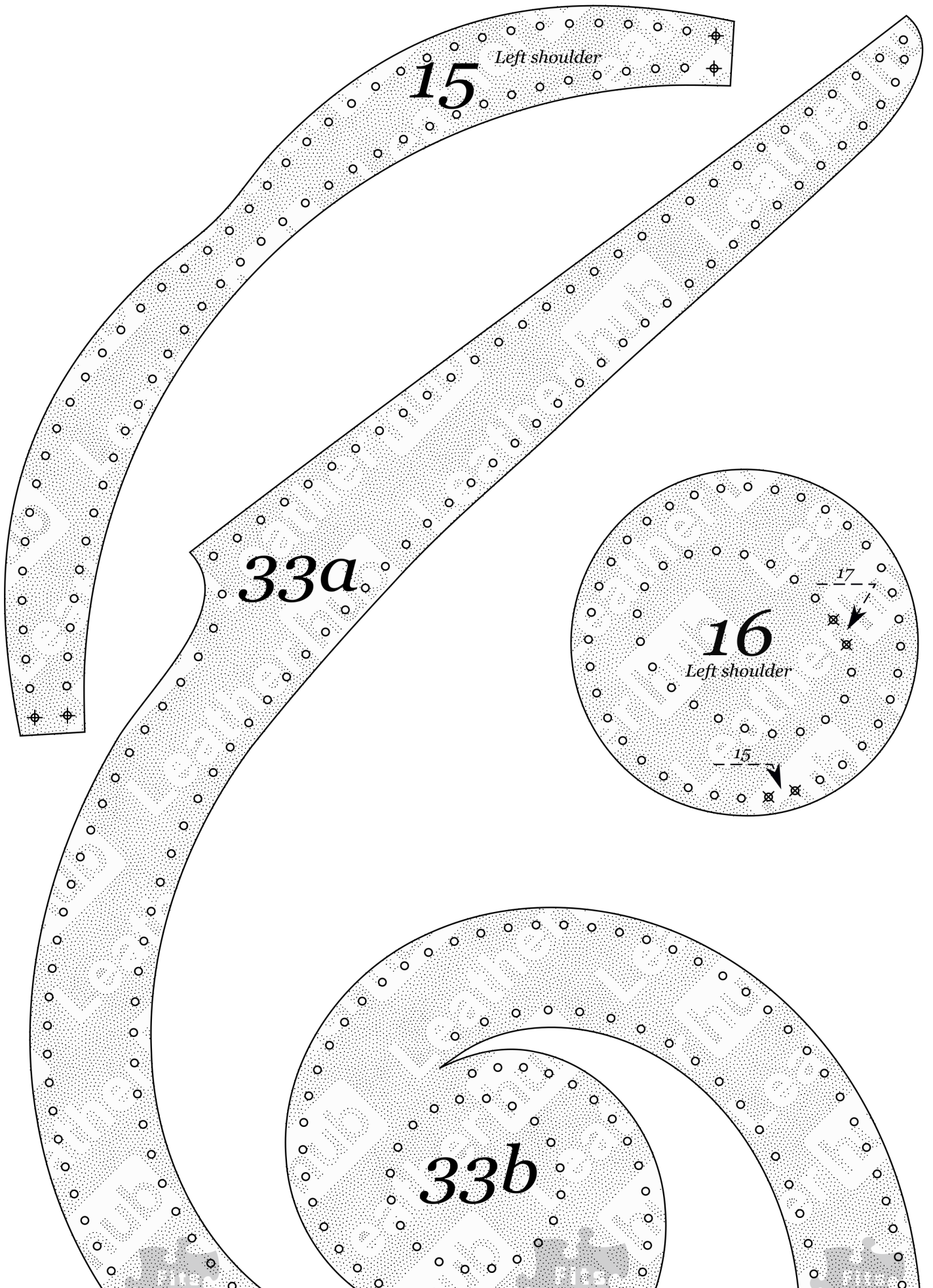

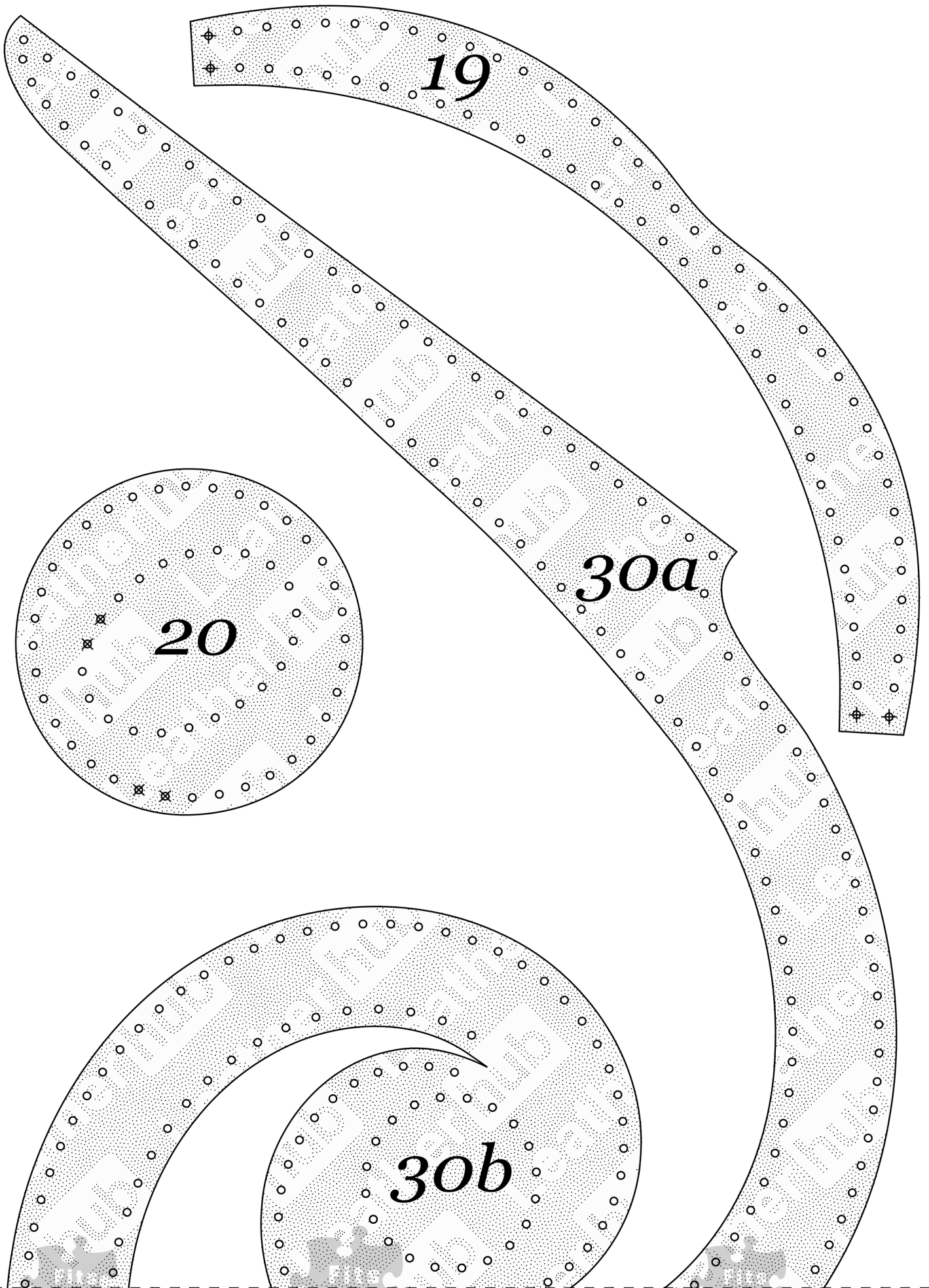

19

20

30a

30b

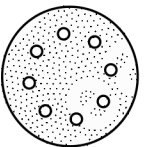
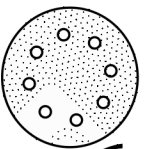
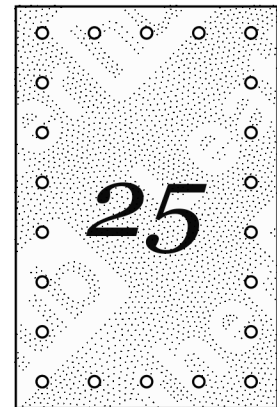
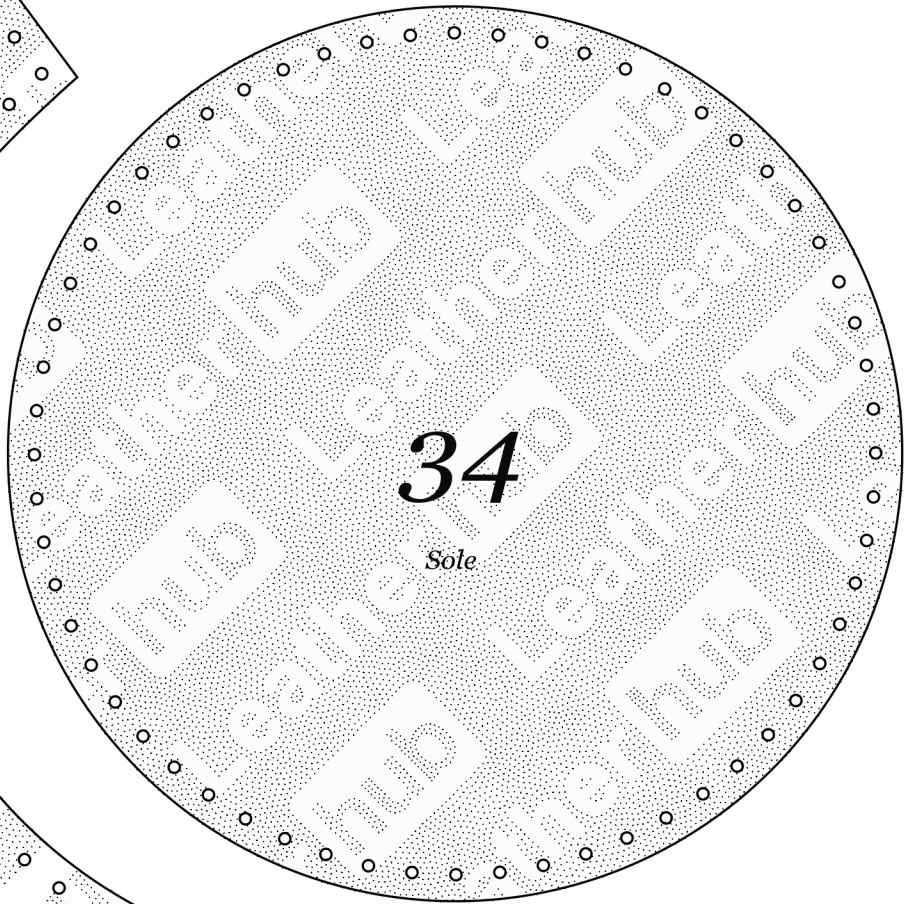
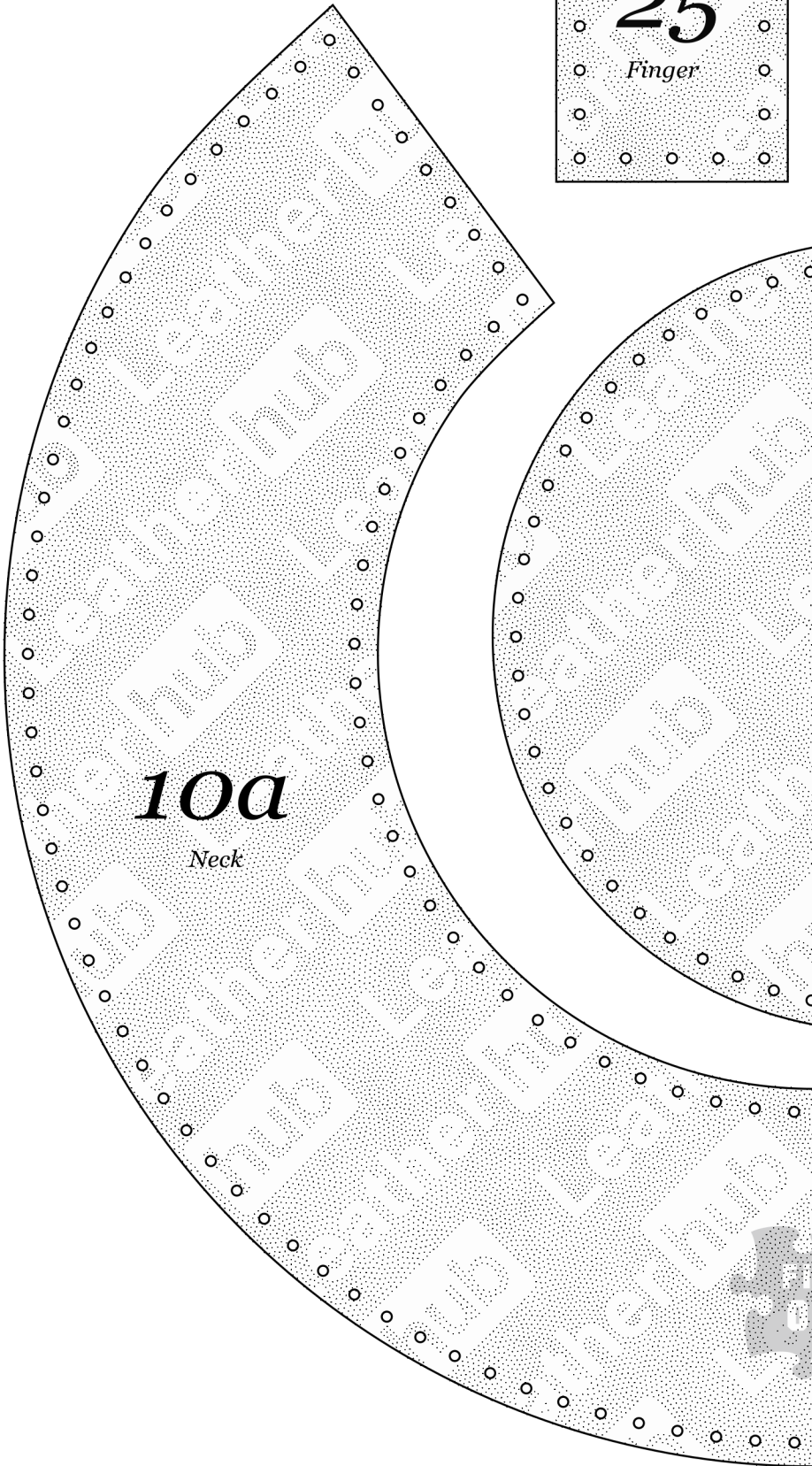
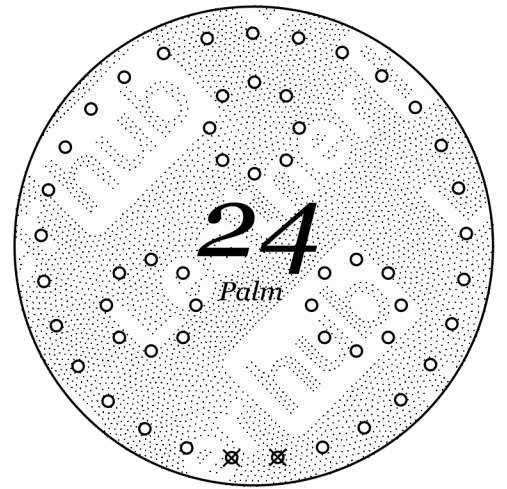

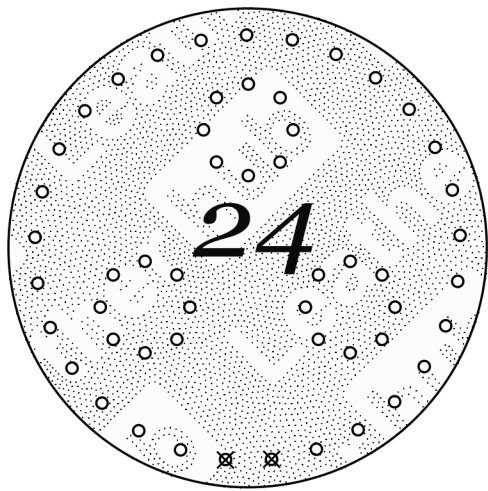

Fingertips

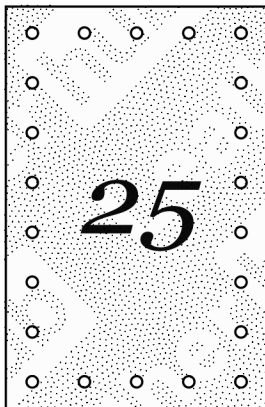
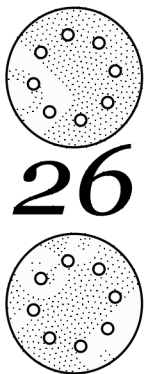
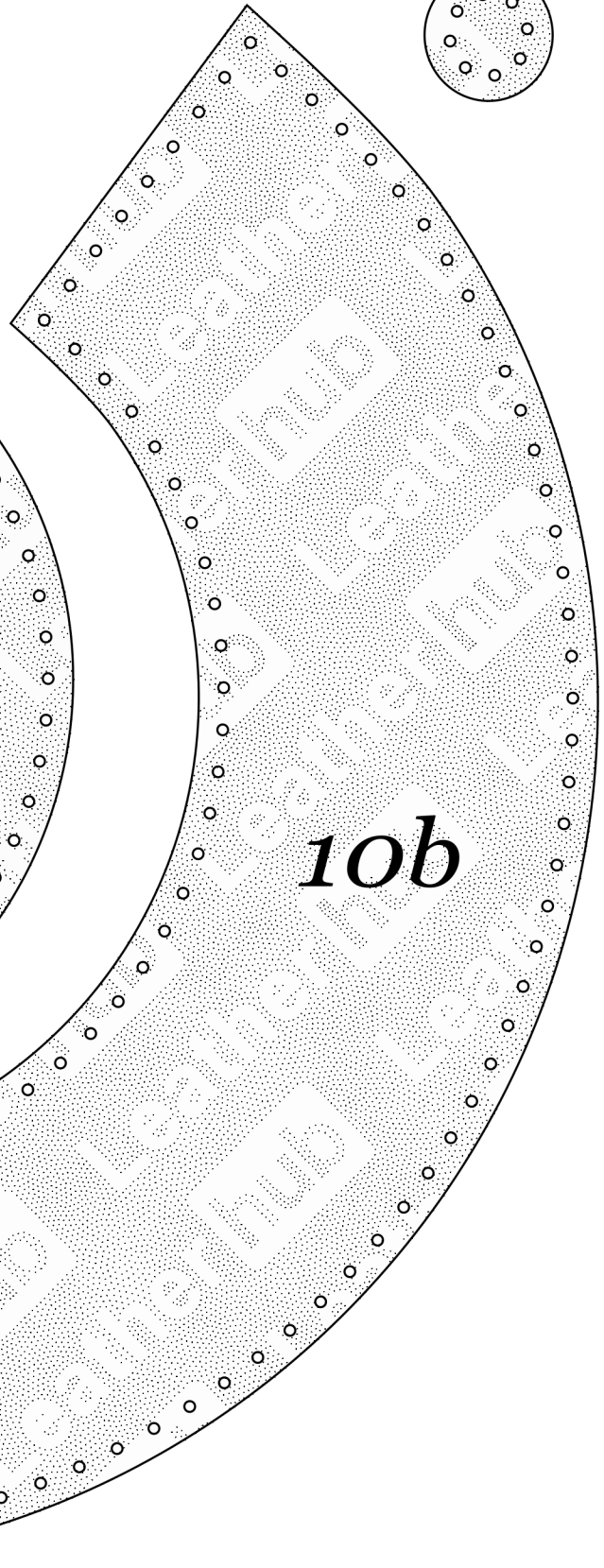
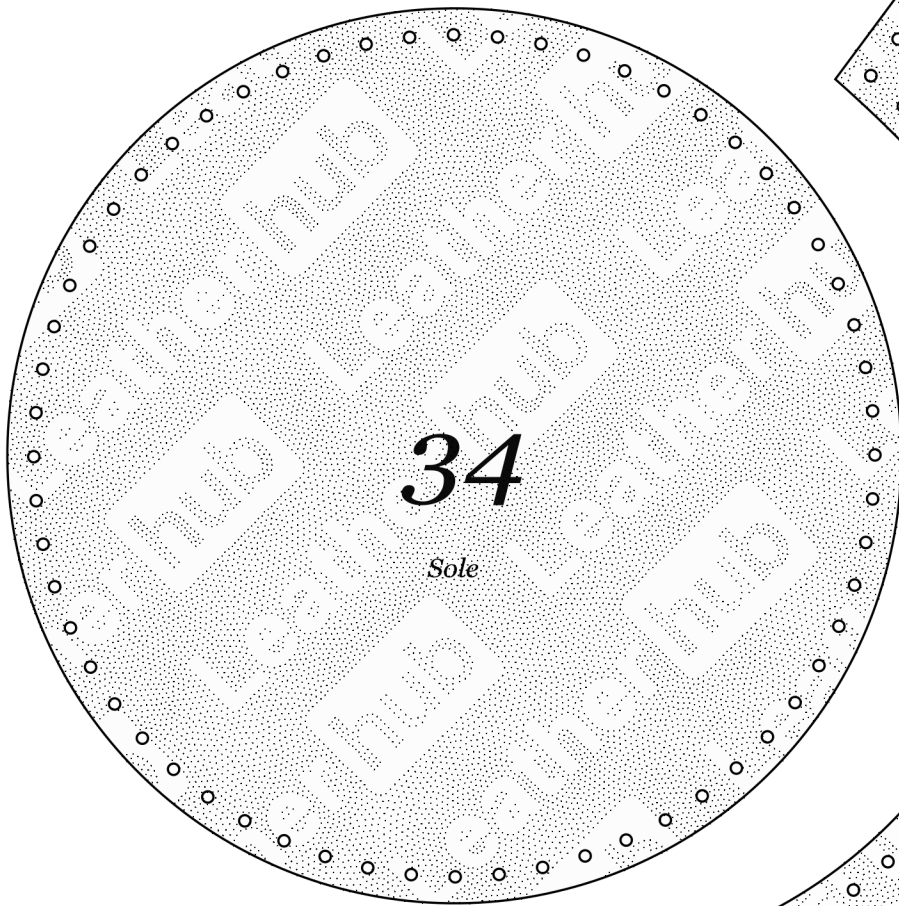
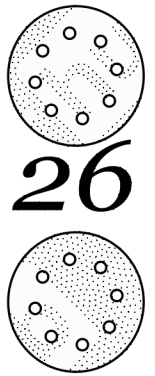

5a

Head

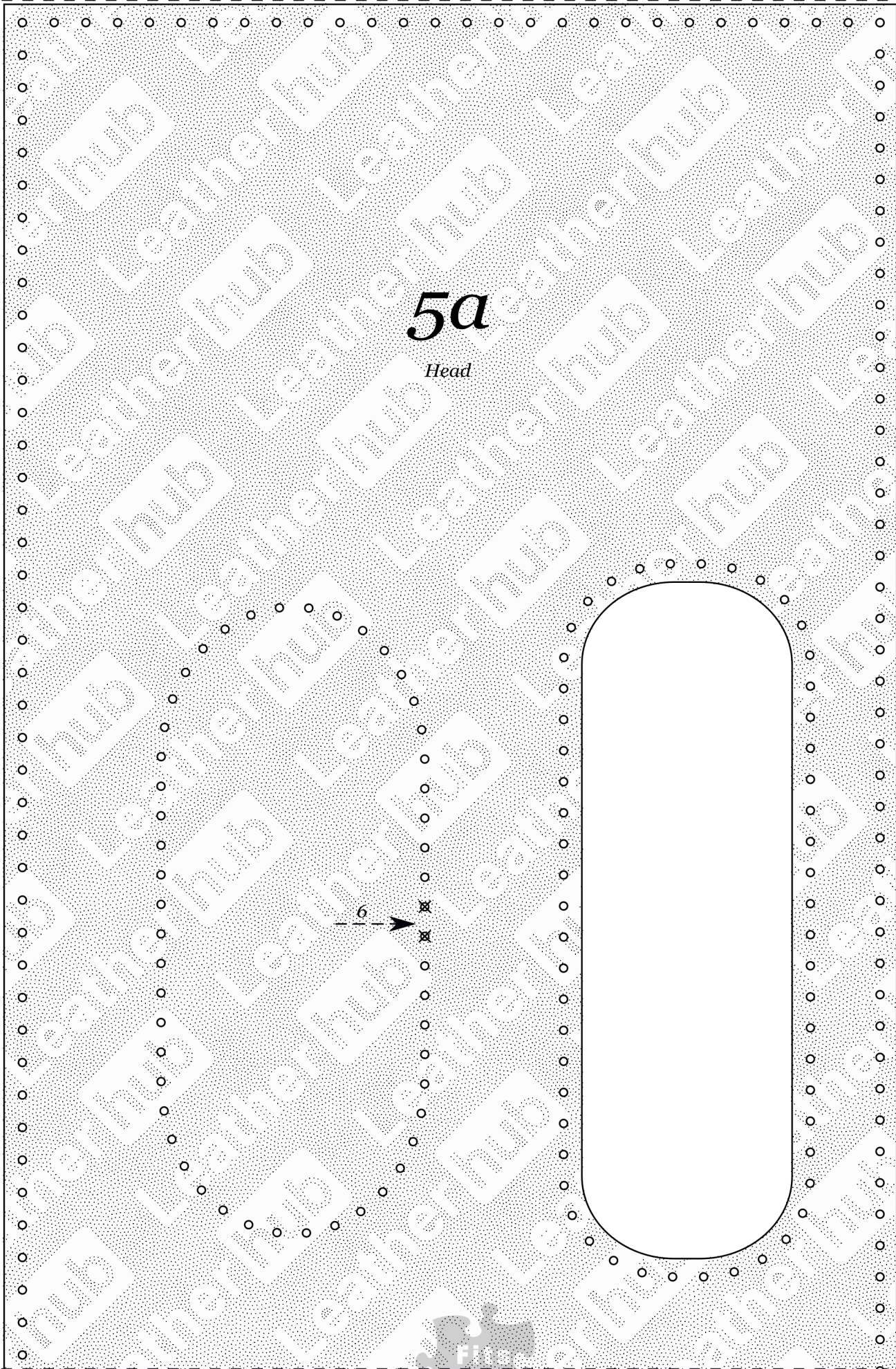

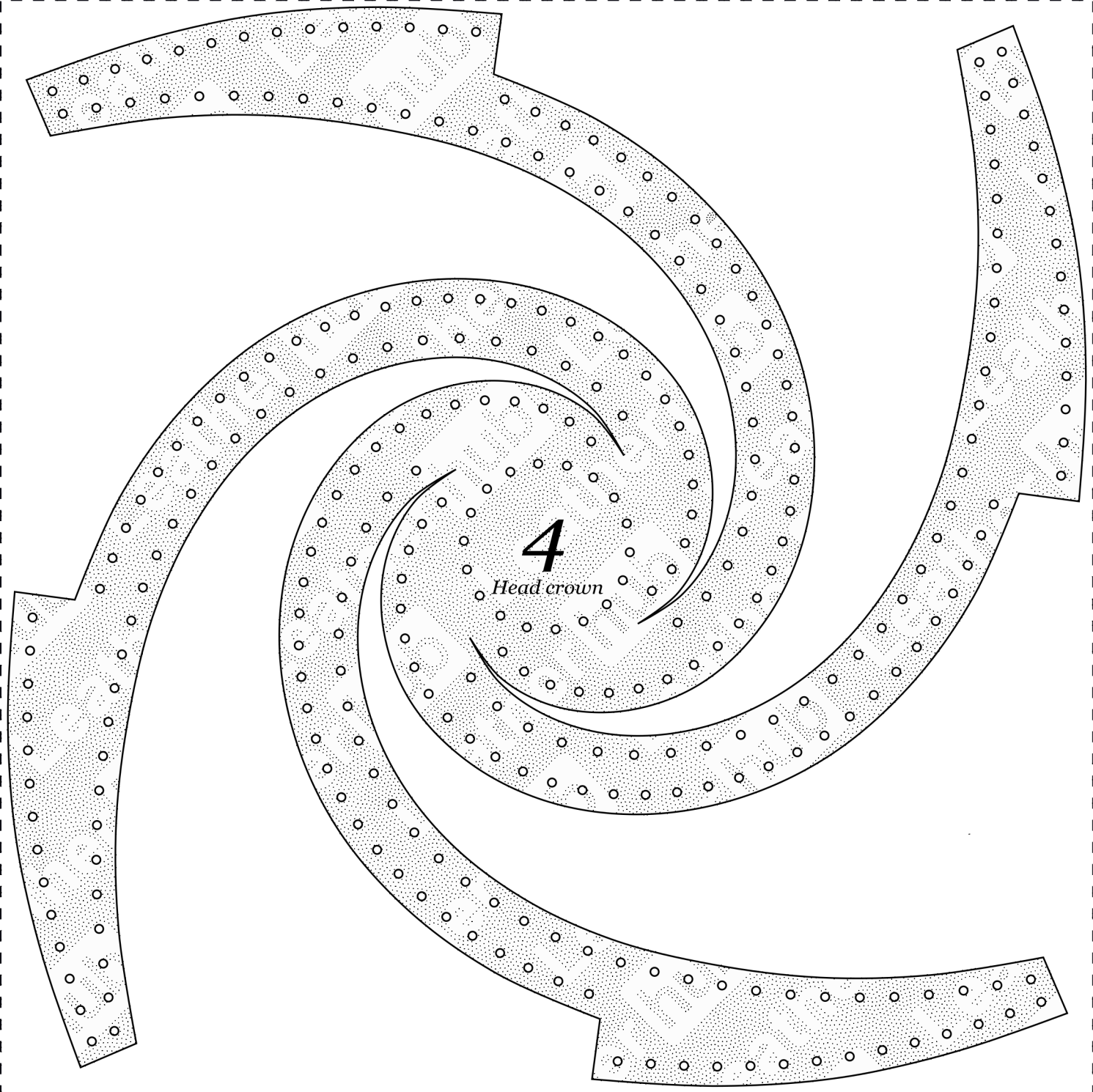

4

Head crown

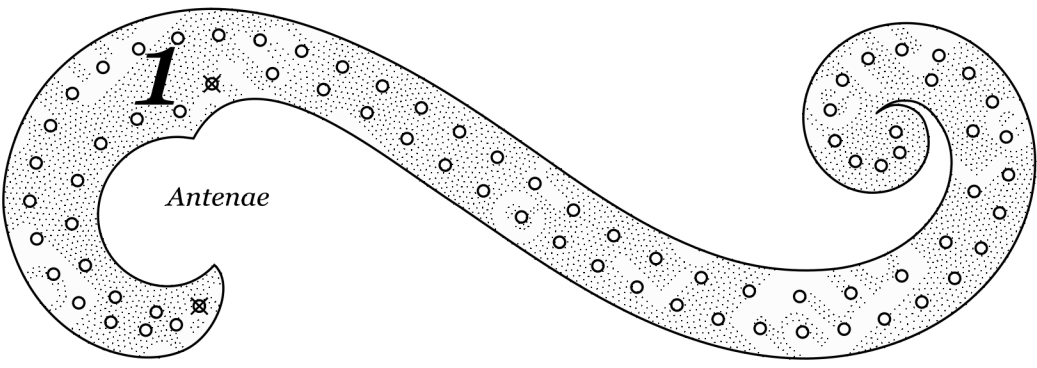

1

Antennae

33d

23 *Wrist*

33c
Foot

3
Antenna

7

Right eye

Part 6 joins across
these holes

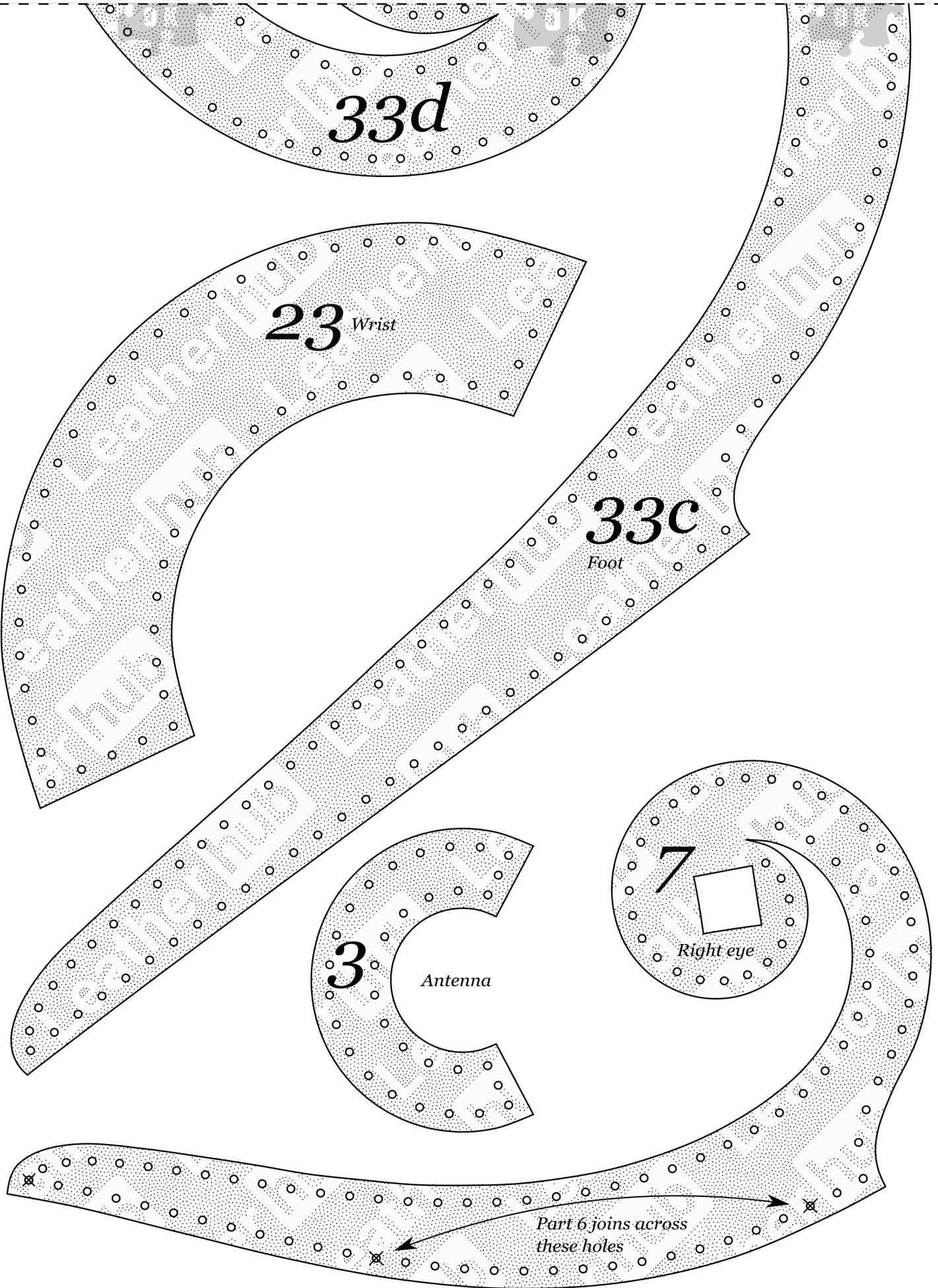

30d

23

30c

8

Left eye

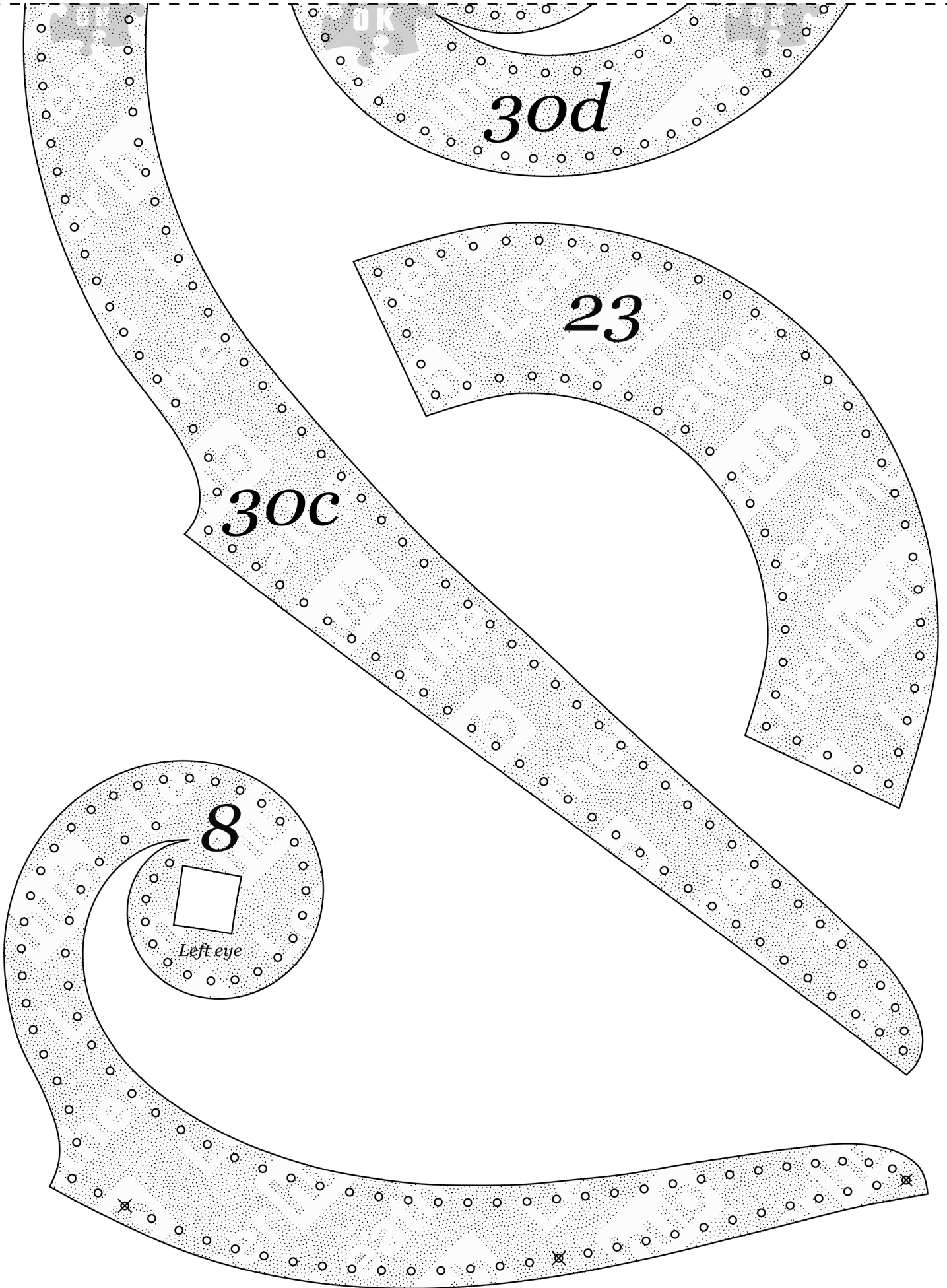

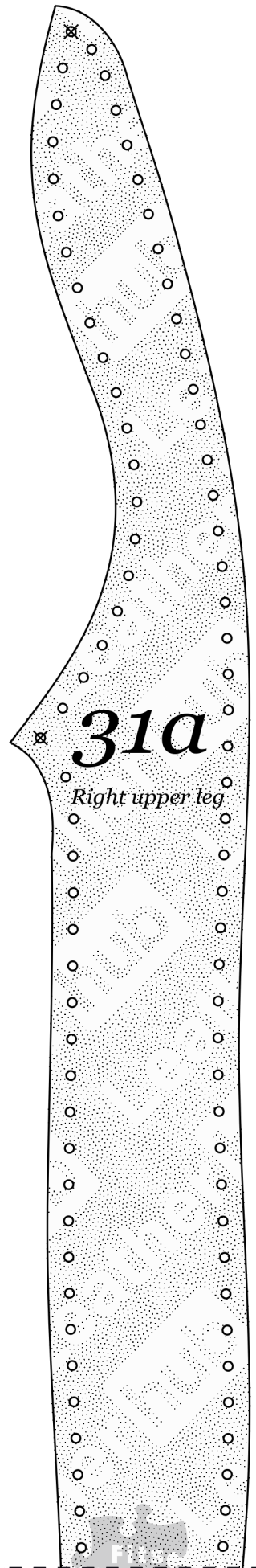
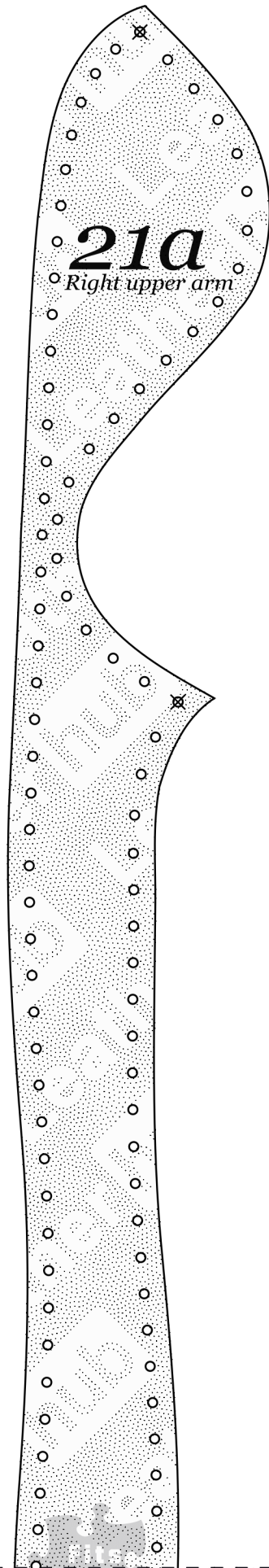
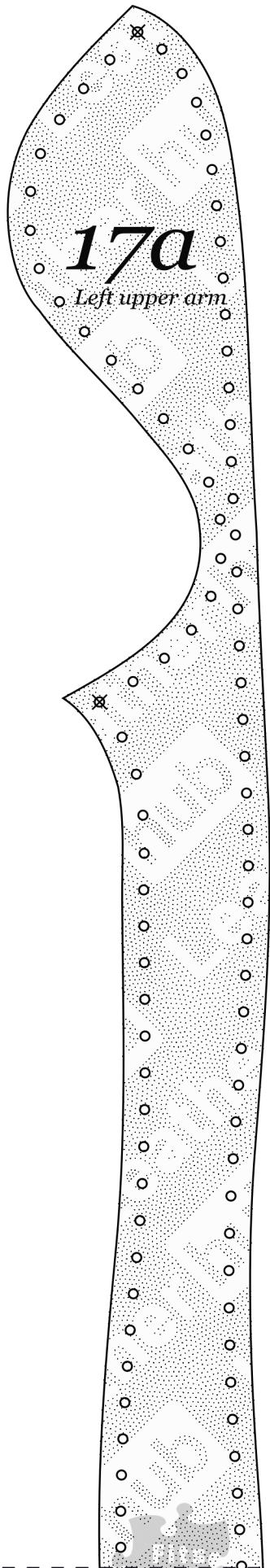

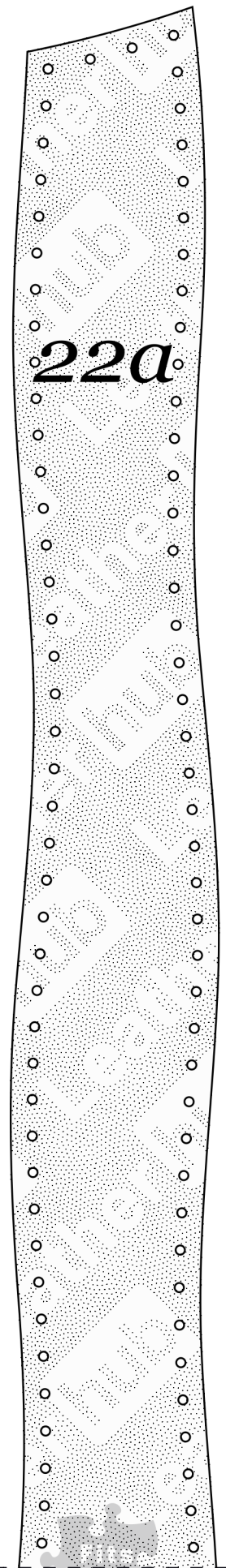
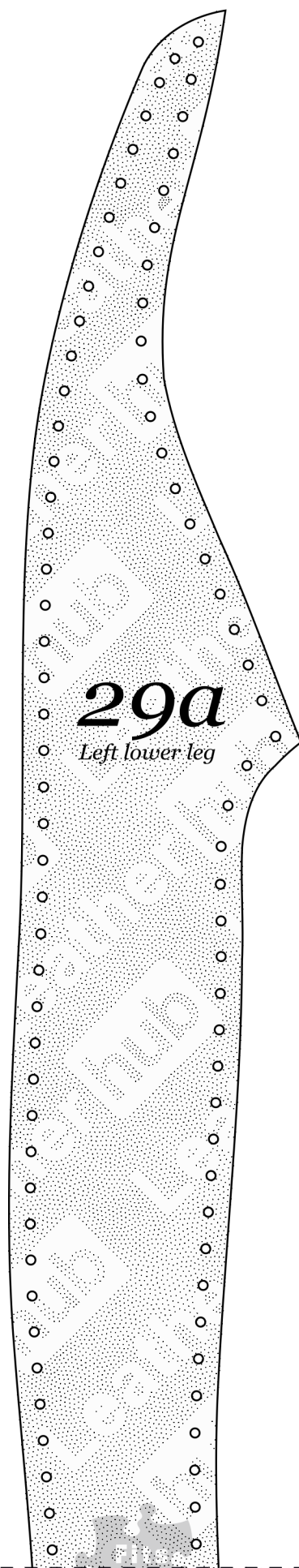
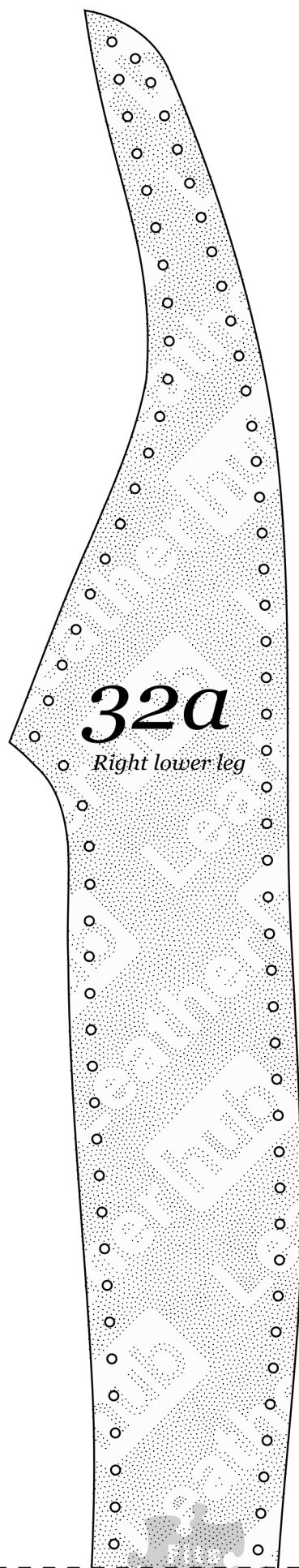
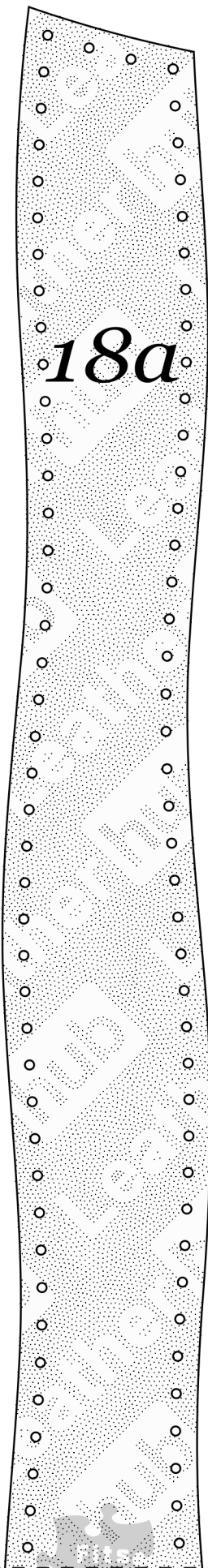

5b

The snap gets set here

13

Door

*Excepting this side, all the sewing
on part 13 is decorative and needs
to be done before attaching part 12*

